

REMER

RUBINETTERIE

SERIE
SERIES

ENERGY

CODICE
CODE

EY08

IMMAGINE - IMAGE

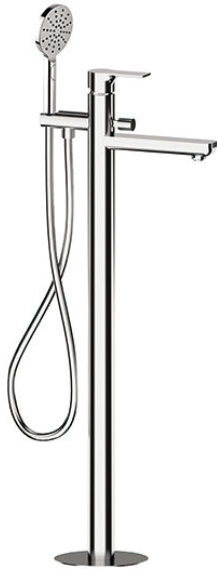

SCHEMA TECNICA - TECHNICAL FEATURES

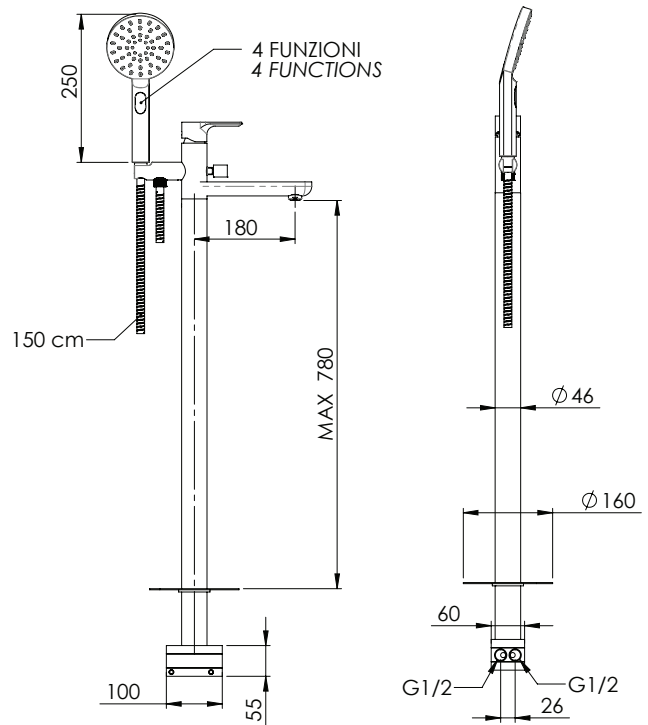





DESCRIZIONE - DESCRIPTION

Miscelatore bordo vasca da pavimento, con deviatore e kit doccia in ottone doccetta a 4 funzioni con pulsante cambio getti, anticalcare e flessibile 150 cm, senza scarico.

Single-lever bath mixer floor mounting, with diverter and brass shower kit, 4 functions antilimestone handshower with button to change jets and flexible hose 150 cm, without waste.

FINITURE - FINISHING

 NO Nero Opaco Matt Black	 BO Bianco Opaco Matt White
 NP Nichel Spazzolato Brushed Nickel	 NPO Nichel Spazzolato Opaco Matt Brushed Nickel
 CR Crom Chrom	

COMPONENTI - COMPONENTS



Cartuccia R52
Cartridge R52



Aeratore 83ABP
Aerator 83ABP

CARATTERISTICHE - FEATURES



Disponibile in Finitura
Available in Finishing



Perfect Tune
Perfect Tune



Senza Scarico
Without Waste



2 Vie
2 Ways



Flessibile Lungo 150 cm
Flexible Length 150 cm



Ampio getto pioggia a risparmio idrico
Large coverage water-saving rain jet



Getto spray ampia copertura e getto intenso esterno a risparmio idrico
Wide coverage spray jet and intense water saving external jet



Getto intenso a risparmio idrico
Intense water-saving jet



Getto soft aerato misciato ad un getto vigoroso a risparmio idrico
Soft aerated jet mixed with a vigorous water-saving jet

REMER Rubinetterie S.p.A.

Via Leonardo Da Vinci, 83 - 20062 Cassano d'Adda (MI) - Italy - Tel. +39 0363 364211 - info@remer.eu - www.remer.eu